

1 13/16" 21" 29 7/8" 21" 3/4" 36" 3/4"

5 7/8" 23 7/8" 1/8"

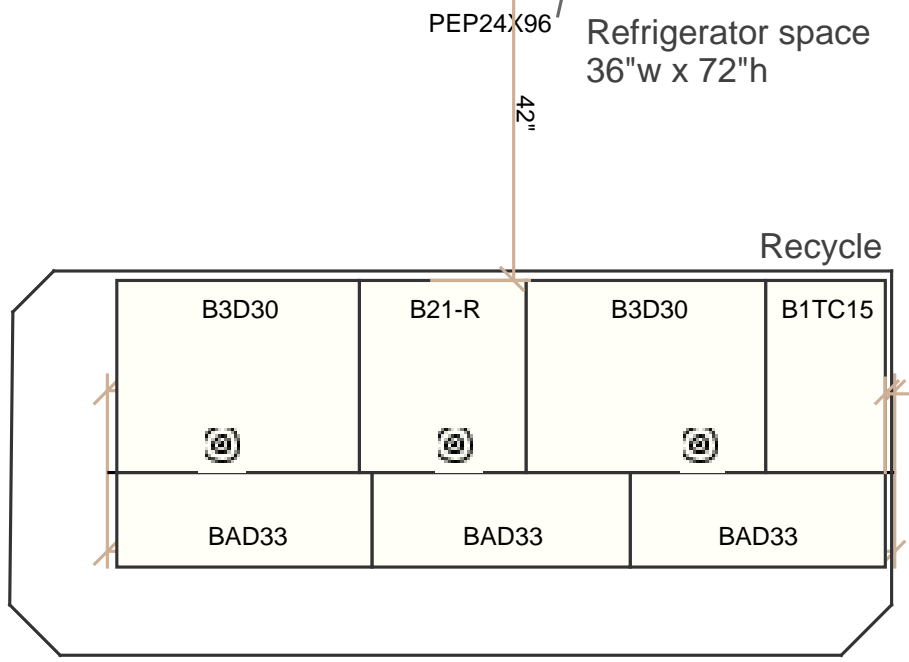

Raised Microwave  
Trash

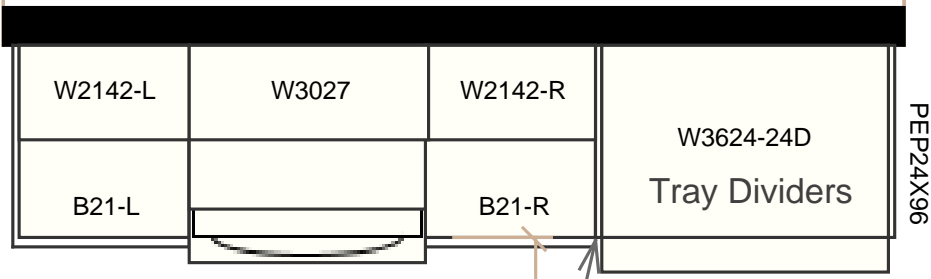
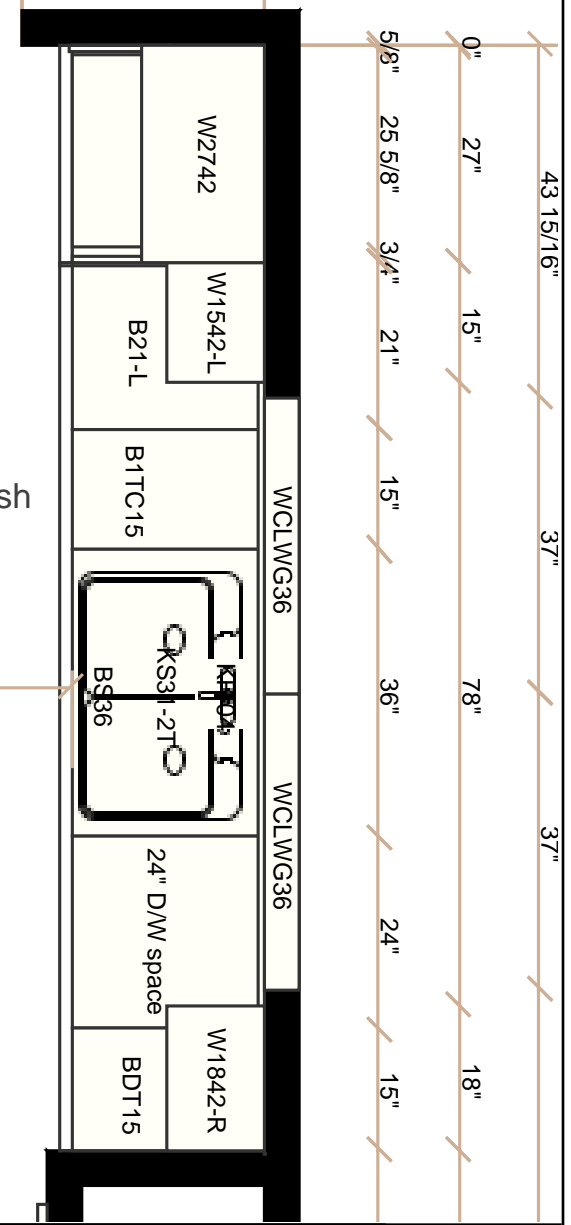

43 15/16" 37" 37" 78" 36" 24" 18" 15"

0" 27" 15" 21" 15" 36" 24" 15"

5/8" 25 5/8" 3/4" 21" 15" 36" 24" 15"

All dimensions and size designations given are subject to verification on job site and adjustment to fit job conditions.



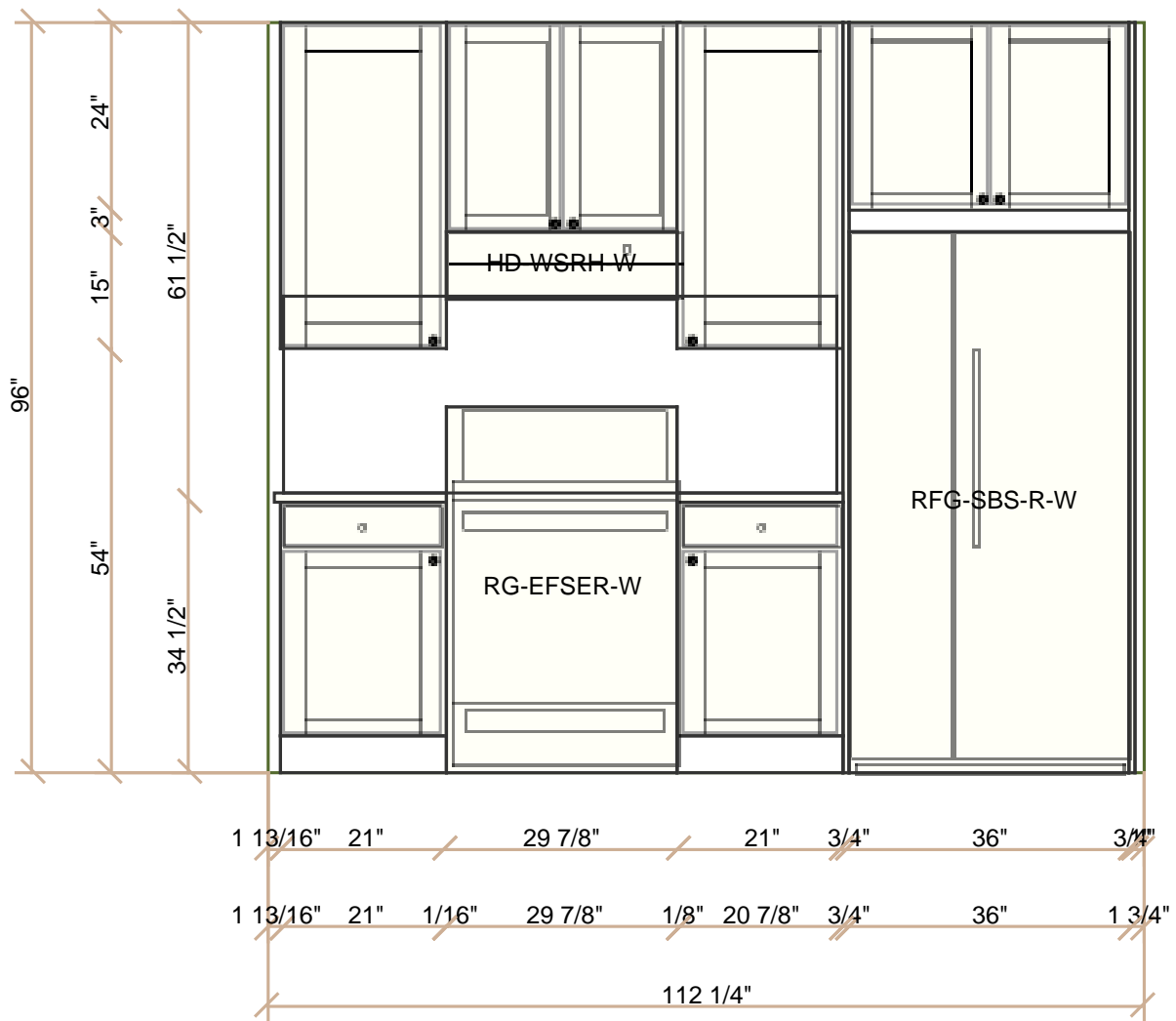

Design drawings are provided for the fair use by the client or his agent in completing the project as listed within this contract. Design plans remain the property of this firm and can not be used or reused without permission.

Designed: 01.20.12  
Printed: 01.20.12

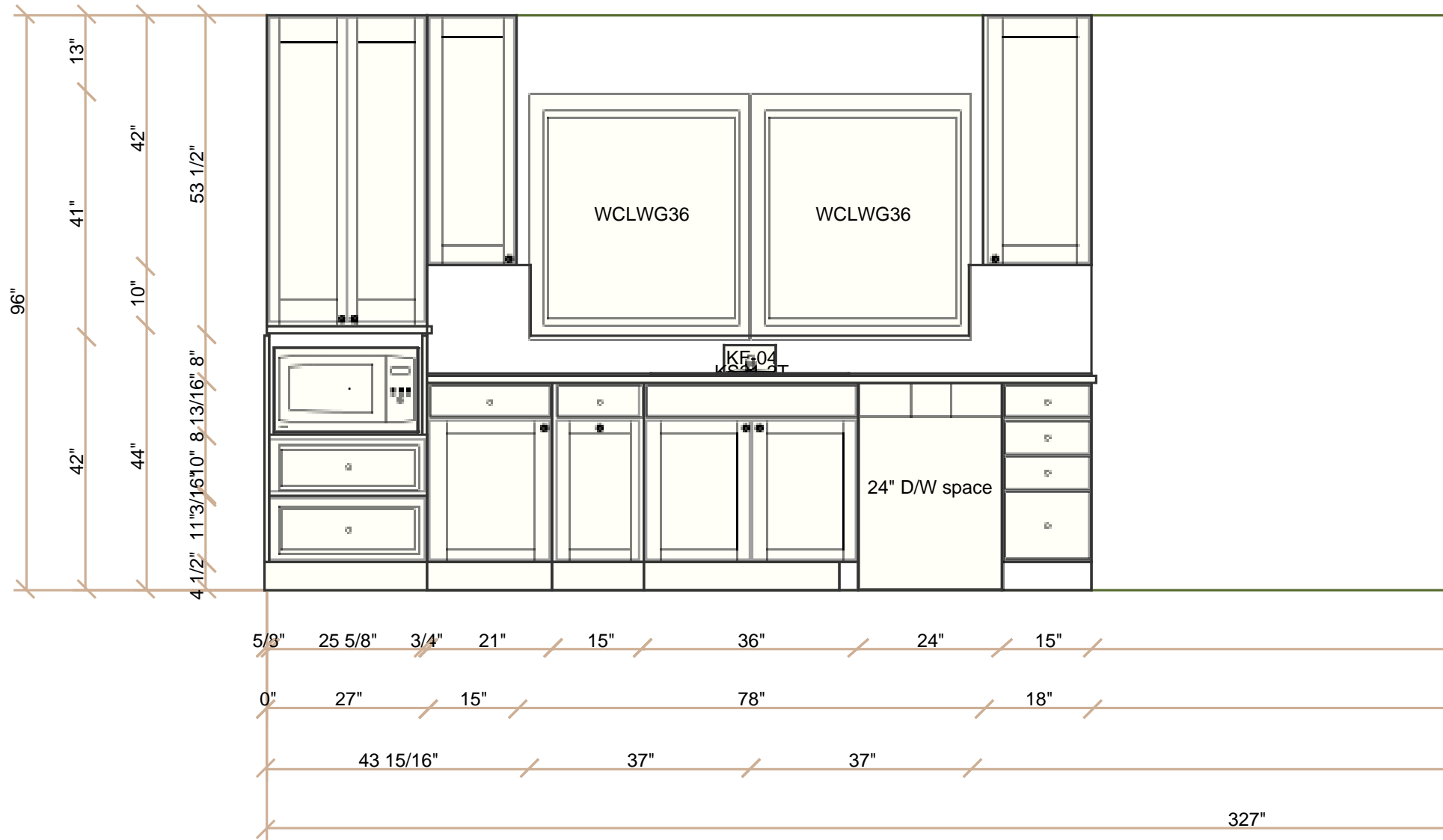

<p>All dimensions and size designations given are subject to verification on job site and adjustment to fit job conditions.</p>	 <p><b>McClurg</b> Remodeling &amp; Construction Services Your Dream. Our Team.</p>	<p>Design drawings are provided for the fair use by the client or his agent in completing the project as listed within this contract. Design plans remain the property of this firm and can not be used or reused without permission.</p>	<p>Designed: 01.20.12 Printed: 01.20.12</p>
<p>Design: Johnson Kitchen</p>		<p>Drawing #: 2</p>	<p>Display settings 1/2" = 1'</p>



<p>All dimensions and size designations given are subject to verification on job site and adjustment to fit job conditions.</p>	 <p>McClurg Remodeling &amp; Construction Services Your Dream. Our Team.</p>	<p>Design drawings are provided for the fair use by the client or his agent in completing the project as listed within this contract. Design plans remain the property of this firm and can not be used or reused without permission.</p>	<p>Designed: 01.20.12 Printed: 01.20.12</p>
<p>Design: Johnson Kitchen</p>		<p>Drawing #: 3</p>	<p>Display settings 1/2" = 1'</p>

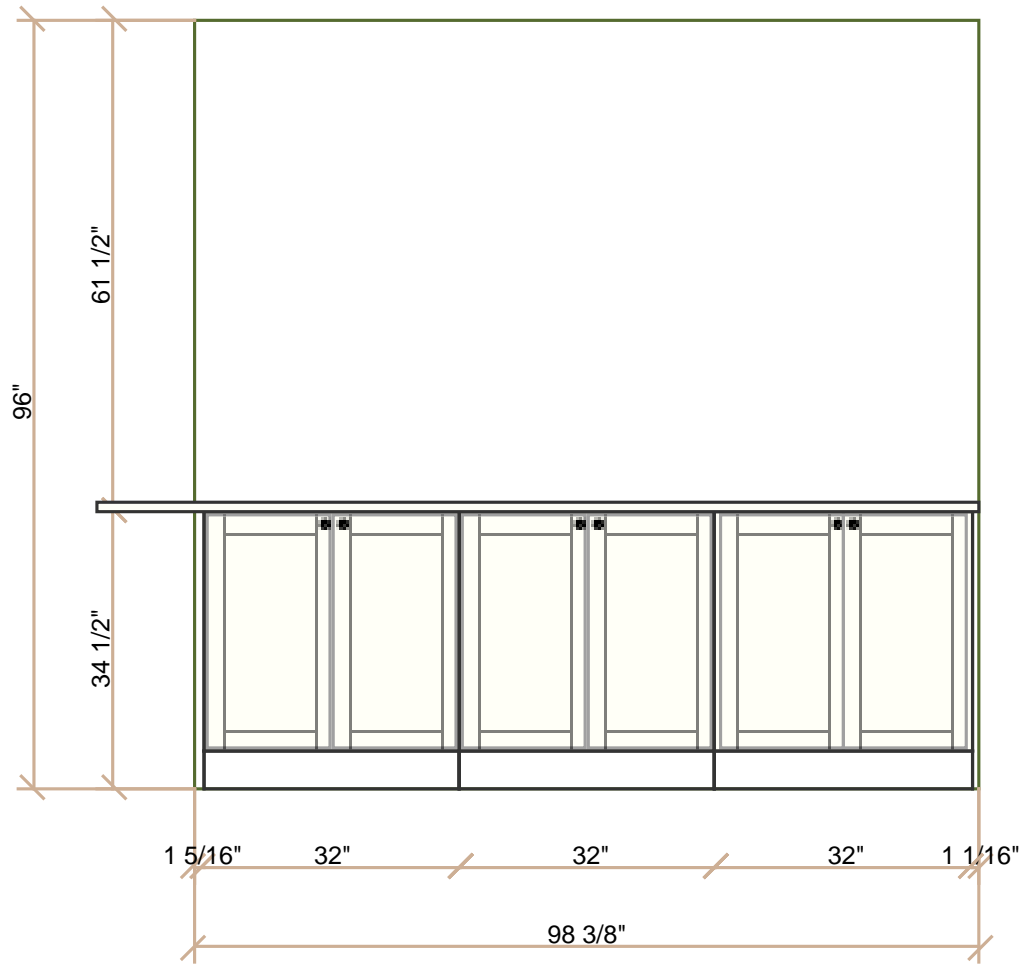

All dimensions and size designations given are subject to verification on job site and adjustment to fit job conditions.



Design drawings are provided for the fair use by the client or his agent in completing the project as listed within this contract. Design plans remain the property of this firm and can not be used or reused without permission.

Designed: 01.20.12  
Printed: 01.20.12

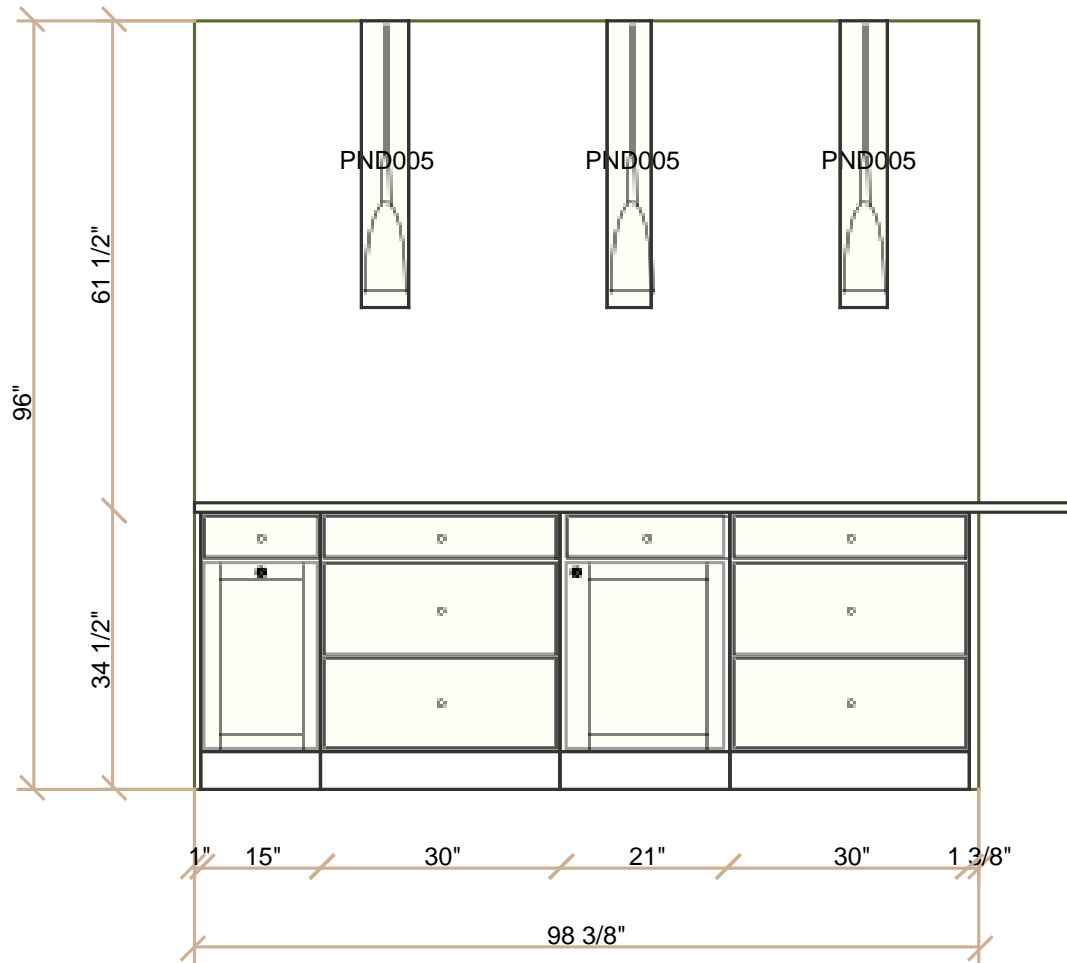

All dimensions and size designations given are subject to verification on job site and adjustment to fit job conditions.



Design drawings are provided for the fair use by the client or his agent in completing the project as listed within this contract. Design plans remain the property of this firm and can not be used or reused without permission.

Designed: 01.20.12  
Printed: 01.20.12